

400 W TVS in SMA

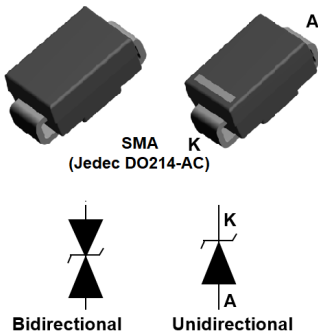

Features

- Peak pulse power:
 - 400 W (10/1000 μ s)
 - 2.3 kW (8/20 μ s)
- Stand-off voltage range from 5 V to 188 V
- Unidirectional and bidirectional types
- Low leakage current:
 - 0.2 μ A at 25 °C
 - 1 μ A at 85 °C
- Operating T_j max: 150 °C
- JEDEC registered package outline

Complies with the following standards

- UL94, V0
- J-STD-020 MSL level 1
- J-STD-002, JESD 22-B102 E3 and MIL-STD-750, method 2026 solderable matte tin plated leads
- JESD-201 class 2 whisker test
- IPC7531 footprint
- JEDEC registered package outline
- IEC 61000-4-4 level 4:
 - 4 kV
- IEC 61000-4-2, C = 150 pF - R = 330 Ω exceeds level 4:
 - 30 kV (air discharge)
 - 30 kV (contact discharge)

Description

The SMAJ series is designed to protect sensitive equipment against electrostatic discharges according to IEC 61000-4-2 and MIL STD 883, method 3015, and electrical overstress according to IEC 61000-4-4 and 5. This device is more generally used against surges below 600 W (10/1000 μ s).

The Planar technology makes it compatible with high-end circuits where low leakage current and high junction temperature are required to provide long term reliability and stability. SMAJ devices are packaged in SMA (SMA footprint in accordance with IPC 7531 standard).

Product status links

[SMAJ5.0A](#), [SMAJ5.0CA](#),
[SMAJ6.0A](#), [SMAJ6.0CA](#),
[SMAJ6.5A](#), [SMAJ6.5CA](#),
[SMAJ8.5A](#), [SMAJ8.5CA](#),
[SMAJ10A](#), [SMAJ10CA](#),
[SMAJ12A](#), [SMAJ12CA](#),
[SMAJ13A](#), [SMAJ13CA](#),
[SMAJ15A](#), [SMAJ15CA](#),
[SMAJ18A](#), [SMAJ18CA](#),
[SMAJ20A](#), [SMAJ20CA](#),
[SMAJ24A](#), [SMAJ24CA](#),
[SMAJ26A](#), [SMAJ26CA](#),
[SMAJ28A](#), [SMAJ28CA](#),
[SMAJ30A](#), [SMAJ30CA](#),
[SMAJ33A](#), [SMAJ33CA](#),
[SMAJ40A](#), [SMAJ40CA](#),
[SMAJ43A](#), [SMAJ43CA](#),
[SMAJ48A](#), [SMAJ48CA](#),
[SMAJ58A](#), [SMAJ58CA](#),
[SMAJ70A](#), [SMAJ70CA](#),
[SMAJ85A](#), [SMAJ85CA](#),
[SMAJ100A](#), [SMAJ100CA](#),
[SMAJ130A](#), [SMAJ130CA](#),
[SMAJ154A](#), [SMAJ154CA](#),
[SMAJ170A](#), [SMAJ170CA](#),
[SMAJ188A](#), [SMAJ188CA](#).

1 Characteristics

Table 1. Absolute maximum ratings ($T_{amb} = 25\text{ }^{\circ}\text{C}$)

| Symbol | Parameter | Value | Unit | |
|-----------|--|---|-------------|--------------------|
| V_{PP} | Peak pulse voltage | IEC 61000-4-2 (C = 150 pF, R = 330 Ω) | | |
| | | Contact discharge | 30 | kV |
| | | Air discharge | 30 | |
| P_{PP} | Peak pulse power dissipation | T_j initial = T_{amb} | 400 | W |
| T_{stg} | Storage temperature range | | -65 to +150 | $^{\circ}\text{C}$ |
| T_j | Operating junction temperature range | | -55 to +150 | $^{\circ}\text{C}$ |
| T_L | Maximum lead temperature for soldering during 10 s | | 260 | $^{\circ}\text{C}$ |

Figure 1. Electrical characteristics - parameter definitions

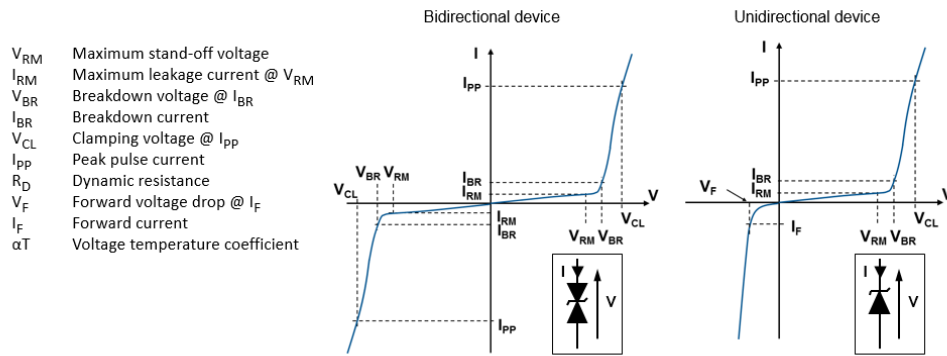

Figure 2. Pulse definition for electrical characteristics

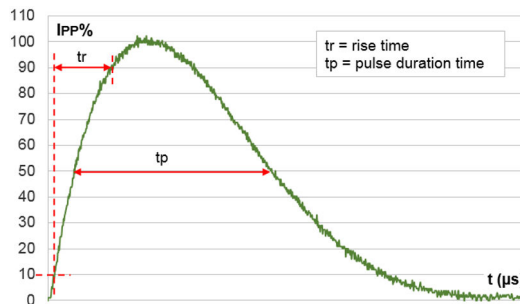

Table 2. Electrical characteristics - parameter values ($T_{amb} = 25\text{ °C}$, unless otherwise specified)

| Type | I_{RM} max at V_{RM} | | | V_{BR} at $I_{BR}^{(1)}$ | | | 10 / 1000 μ s | | | 8 / 20 μ s | | | αT |
|-------------|--------------------------|-------|-----|----------------------------|------|----|-------------------|----------------|----------|-------------------|----------------|----------|---------------------|
| | | | | | | | $V_{CL}^{(2)(3)}$ | $I_{PP}^{(4)}$ | R_D | $V_{CL}^{(2)(3)}$ | $I_{PP}^{(4)}$ | R_D | |
| | 25 °C | 85 °C | | Min. | Typ. | | Max. | | Max. | Max. | | Max. | Max. |
| | μ A | | V | V | | mA | V | A | Ω | V | A | Ω | $10^{-4}/\text{°C}$ |
| SMAJ5.0A/CA | 20 | 50 | 5.0 | 6.40 | 6.74 | 10 | 9.2 | 43.5 | 0.049 | 13.4 | 174 | 0.036 | 5.7 |
| SMAJ6.0A/CA | 20 | 50 | 6.0 | 6.70 | 7.05 | 10 | 10.3 | 38.8 | 0.075 | 13.7 | 170 | 0.037 | 5.9 |
| SMAJ6.5A/CA | 20 | 50 | 6.5 | 7.20 | 7.58 | 10 | 11.2 | 35.7 | 0.091 | 14.5 | 160 | 0.041 | 6.1 |
| SMAJ8.5A/CA | 20 | 50 | 8.5 | 9.4 | 9.9 | 1 | 14.4 | 27.7 | 0.145 | 19.5 | 124 | 0.073 | 7.3 |
| SMAJ10A/CA | 0.2 | 1 | 10 | 11.1 | 11.7 | 1 | 17 | 23.5 | 0.201 | 21.7 | 106 | 0.089 | 7.8 |
| SMAJ12A/CA | 0.2 | 1 | 12 | 13.3 | 14.0 | 1 | 19.9 | 20.1 | 0.259 | 25.3 | 91 | 0.116 | 8.3 |
| SMAJ13A/CA | 0.2 | 1 | 13 | 14.4 | 15.2 | 1 | 21.5 | 18.6 | 0.298 | 27.2 | 85 | 0.132 | 8.4 |
| SMAJ15A/CA | 0.2 | 1 | 15 | 16.7 | 17.6 | 1 | 24.4 | 16.4 | 0.361 | 32.5 | 71 | 0.197 | 8.8 |
| SMAJ18A/CA | 0.2 | 1 | 18 | 20.0 | 21.1 | 1 | 29.2 | 13.7 | 0.514 | 39.3 | 59 | 0.291 | 9.2 |
| SMAJ20A/CA | 0.2 | 1 | 20 | 22.2 | 23.4 | 1 | 32.4 | 12.3 | 0.637 | 42.8 | 54 | 0.338 | 9.4 |
| SMAJ24A/CA | 0.2 | 1 | 24 | 26.7 | 28.1 | 1 | 38.9 | 10.3 | 0.912 | 50 | 46 | 0.446 | 9.6 |
| SMAJ26A/CA | 0.2 | 1 | 26 | 28.9 | 30.4 | 1 | 42.1 | 9.5 | 1.07 | 53.5 | 43 | 0.502 | 9.7 |
| SMAJ28A/CA | 0.2 | 1 | 28 | 31.1 | 32.7 | 1 | 45.4 | 8.8 | 1.26 | 59 | 39 | 0.632 | 9.8 |
| SMAJ30A/CA | 0.2 | 1 | 30 | 33.3 | 35.1 | 1 | 48.4 | 8.3 | 1.39 | 64.3 | 36 | 0.762 | 9.9 |
| SMAJ33A/CA | 0.2 | 1 | 33 | 36.7 | 38.6 | 1 | 53.3 | 7.5 | 1.70 | 69.7 | 33 | 0.884 | 10.0 |
| SMAJ40A/CA | 0.2 | 1 | 40 | 44.4 | 46.7 | 1 | 64.5 | 6.2 | 2.49 | 84 | 27 | 1.30 | 10.1 |
| SMAJ43A/CA | 0.2 | 1 | 43 | 47.8 | 50.3 | 1 | 69.4 | 5.7 | 2.91 | 91 | 25 | 1.53 | 10.2 |
| SMAJ48A/CA | 0.2 | 1 | 48 | 53.3 | 56.1 | 1 | 77.4 | 5.2 | 3.56 | 100 | 23 | 1.79 | 10.3 |
| SMAJ58A/CA | 0.2 | 1 | 58 | 64.4 | 67.8 | 1 | 93.6 | 4.3 | 5.21 | 121 | 19 | 2.62 | 10.4 |
| SMAJ70A/CA | 0.2 | 1 | 70 | 77.8 | 81.9 | 1 | 113 | 3.5 | 7.72 | 146 | 16 | 3.75 | 10.5 |
| SMAJ85A/CA | 0.2 | 1 | 85 | 94 | 99 | 1 | 137 | 2.9 | 11.4 | 178 | 13 | 5.70 | 10.6 |
| SMAJ100A/CA | 0.2 | 1 | 100 | 111 | 117 | 1 | 162 | 2.5 | 15.7 | 212 | 11 | 8.10 | 10.7 |
| SMAJ130A/CA | 0.2 | 1 | 130 | 144 | 152 | 1 | 209 | 1.9 | 26.0 | 265 | 9 | 11.7 | 10.8 |
| SMAJ154A/CA | 0.2 | 1 | 154 | 171 | 180 | 1 | 246 | 1.6 | 35.6 | 317 | 7 | 18.3 | 10.8 |
| SMAJ170A/CA | 0.2 | 1 | 170 | 189 | 199 | 1 | 275 | 1.4 | 47.2 | 353 | 6.5 | 22.2 | 10.8 |
| SMAJ188A/CA | 0.2 | 1 | 188 | 209 | 220 | 1 | 328 | 1.4 | 69.3 | 388 | 6 | 26.2 | 10.8 |

1. To calculate V_{BR} versus T_j : V_{BR} at $T_j = V_{BR}$ at $25\text{ °C} \times (1 + \alpha T \times (T_j - 25))$
2. To calculate V_{CL} versus T_j : V_{CL} at $T_j = V_{CL}$ at $25\text{ °C} \times (1 + \alpha T \times (T_j - 25))$
3. To calculate V_{CL} max versus $I_{PPappli}$: $V_{CLmax} = V_{CL} - R_D \times (I_{PP} - I_{PPappli})$ where $I_{PPappli}$ is the surge current in the application.
4. Surge capability given for both directions for unidirectional and bidirectional devices

1.1 Characteristics (curves)

Figure 3. Maximum peak power dissipation versus initial junction temperature

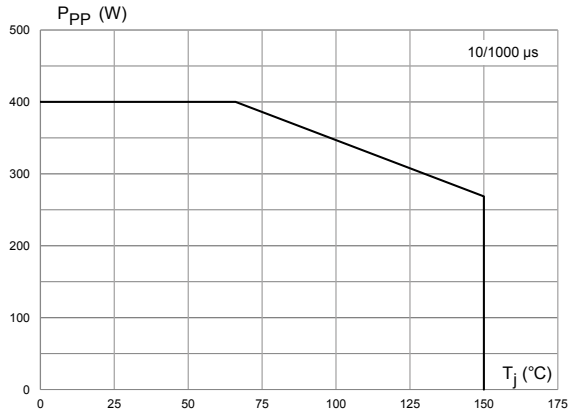

Figure 4. Maximum peak pulse power versus exponential pulse duration

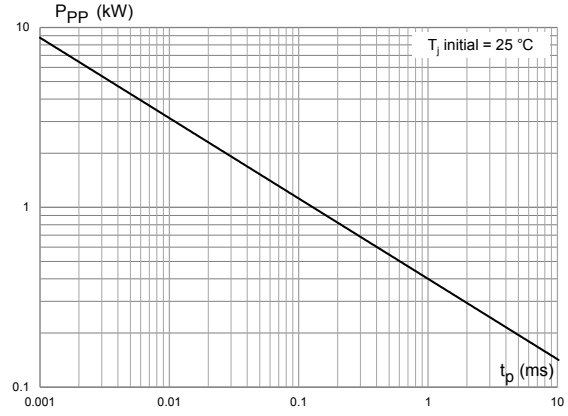

Figure 5. Maximum peak pulse current versus clamping voltage

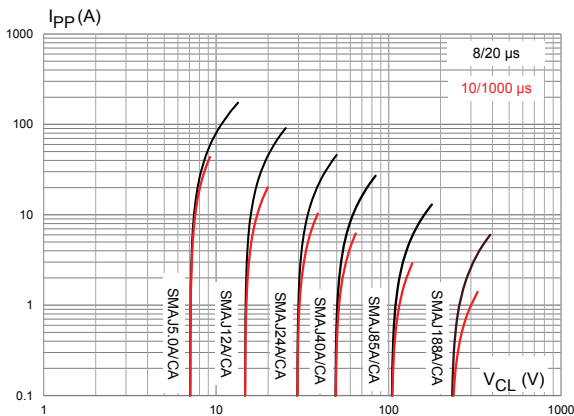

Figure 6. Dynamic resistance versus pulse duration

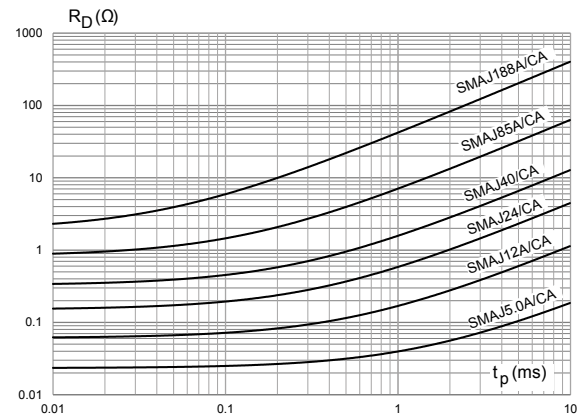

Figure 7. Junction capacitance versus reverse applied voltage (unidirectional type)

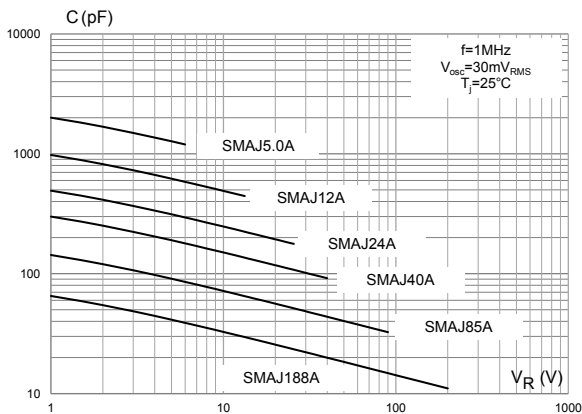

Figure 8. Junction capacitance versus applied voltage (bidirectional type)

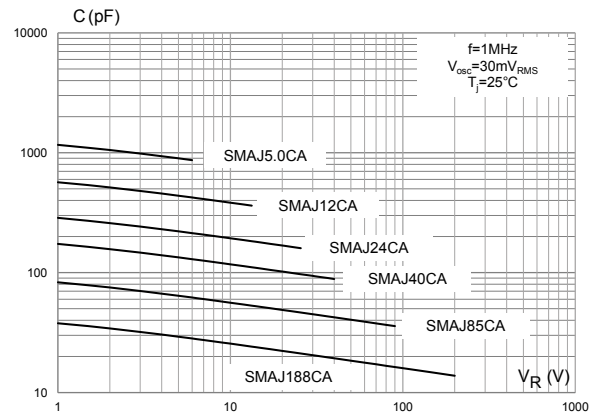

Figure 9. Leakage current versus junction temperature

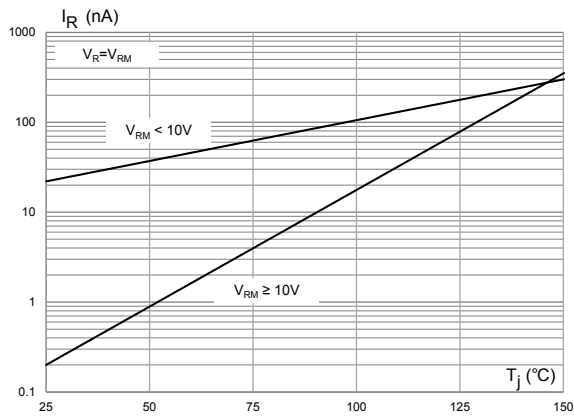

Figure 10. Peak forward voltage drop versus peak forward current

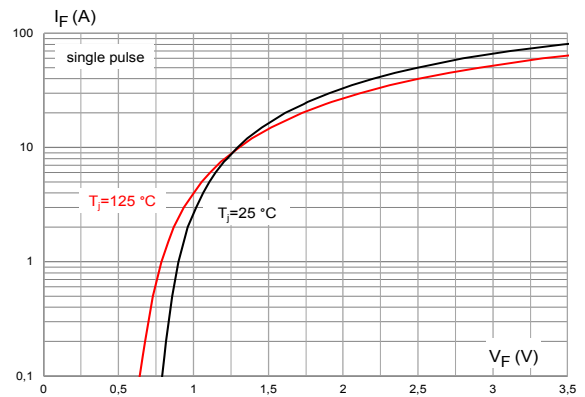

Figure 11. Thermal impedance junction to ambient versus pulse duration

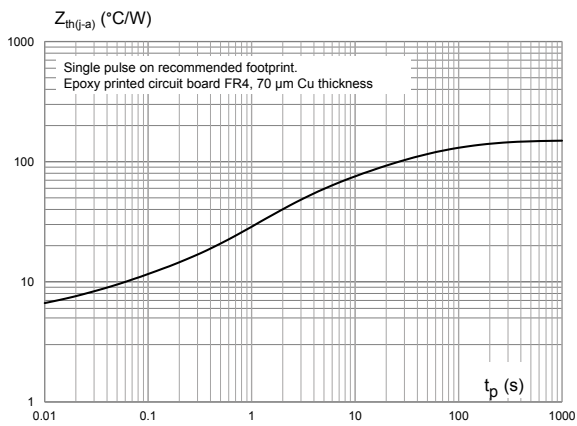
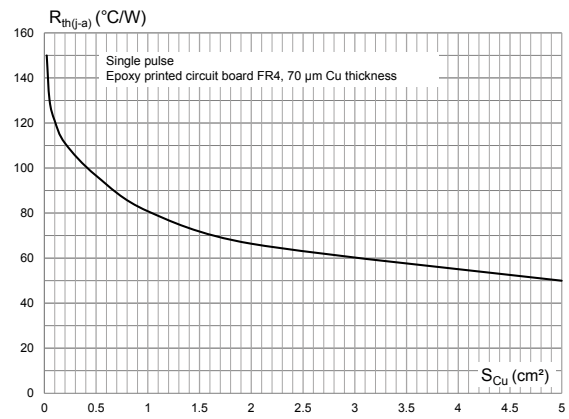

Figure 12. Thermal resistance junction to ambient versus copper area under each lead



2 Package information

In order to meet environmental requirements, ST offers these devices in different grades of **ECOPACK** packages, depending on their level of environmental compliance. ECOPACK specifications, grade definitions and product status are available at: www.st.com. ECOPACK is an ST trademark.

2.1 SMA package information

Figure 13. SMA package outline

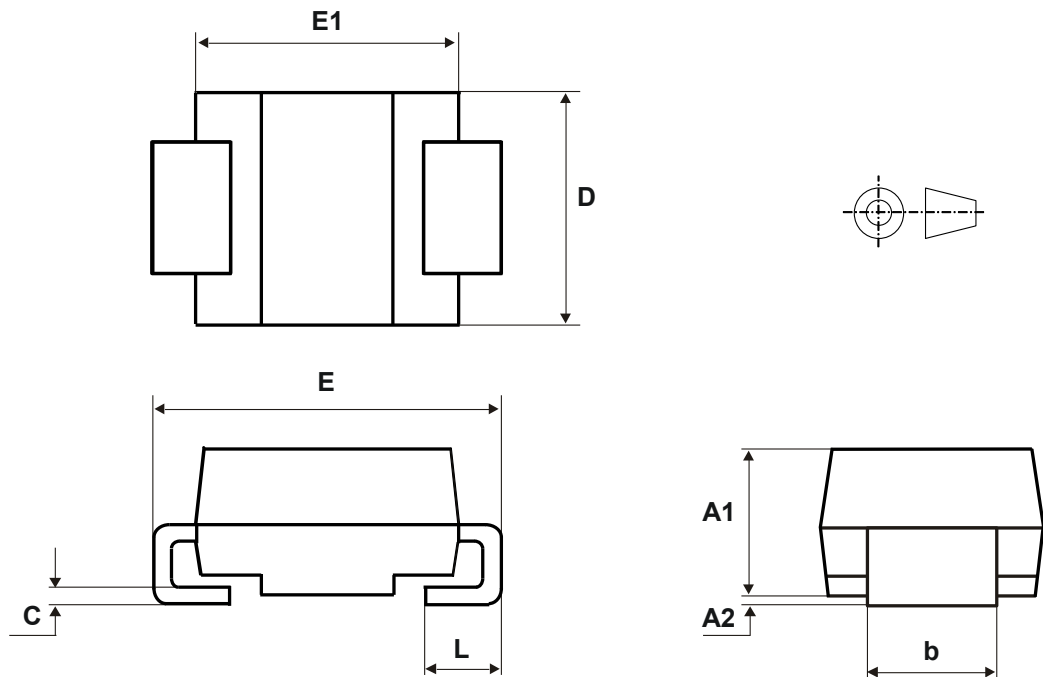

Table 3. SMA package mechanical data

| Ref. | Dimensions | | | |
|------|-------------|------|-----------------------|-------|
| | Millimeters | | Inches ⁽¹⁾ | |
| | Min. | Max. | Min. | Max. |
| A1 | 1.90 | 2.45 | 0.074 | 0.097 |
| A2 | 0.05 | 0.20 | 0.001 | 0.008 |
| b | 1.25 | 1.65 | 0.049 | 0.065 |
| c | 0.15 | 0.40 | 0.005 | 0.016 |
| D | 2.25 | 2.90 | 0.088 | 0.115 |
| E | 4.80 | 5.35 | 0.188 | 0.211 |
| E1 | 3.95 | 4.60 | 0.155 | 0.182 |
| L | 0.75 | 1.50 | 0.029 | 0.060 |

1. Values in inches are converted from mm.

Figure 14. SMA recommended footprint in mm (inches)

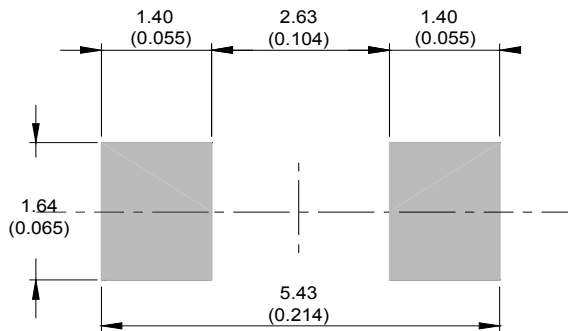

Figure 15. SMA marking

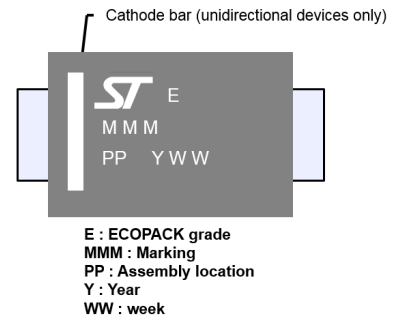
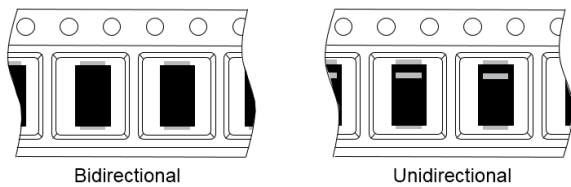

Figure 16. Package orientation in reel



Taped according to EIA-481
 Pocket dimensions are not on scale.
 Pocket shape may vary depending on package
 On bidirectional devices, marking and logo may not be always in the same direction.

Figure 17. Tape and reel orientation

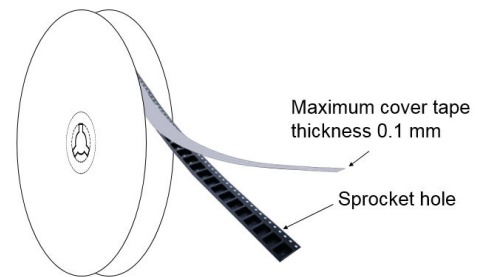

Figure 18. 13" reel dimension values (mm)

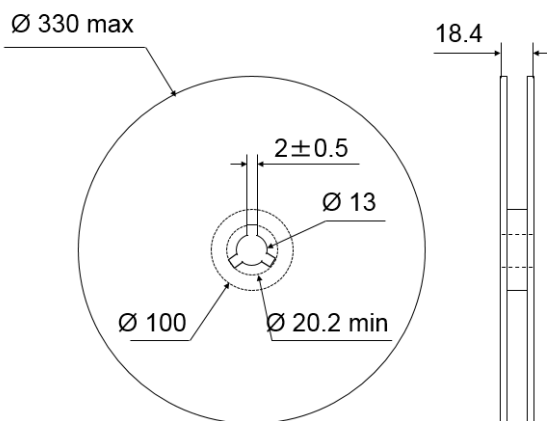

Figure 19. Inner box dimension values (mm)

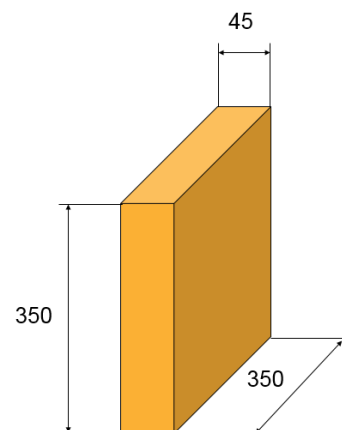
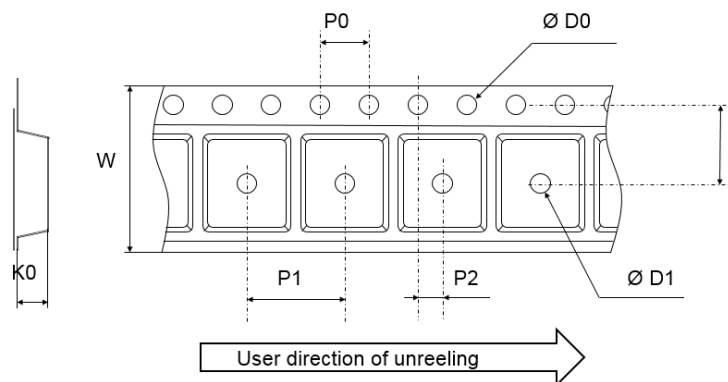

Figure 20. Tape outline



Note: Pocket dimensions are not on scale
Pocket shape may vary depending on package

Table 4. Tape dimension values

| Ref. | Dimensions | | |
|------|-------------|-------|-------|
| | Millimeters | | |
| | Min. | Typ. | Max. |
| D0 | 1.40 | 1.50 | 1.60 |
| D1 | 1.50 | | |
| F | 5.40 | 5.50 | 5.60 |
| K0 | 2.26 | 2.36 | 2.46 |
| P0 | 3.90 | 4.00 | 4.10 |
| P1 | 3.90 | 4.00 | 4.10 |
| P2 | 1.95 | 2.00 | 2.05 |
| W | 11.70 | 12.00 | 12.30 |

2.2 Reflow profile

Figure 21. ST ECOPACK recommended soldering reflow profile for PCB mounting

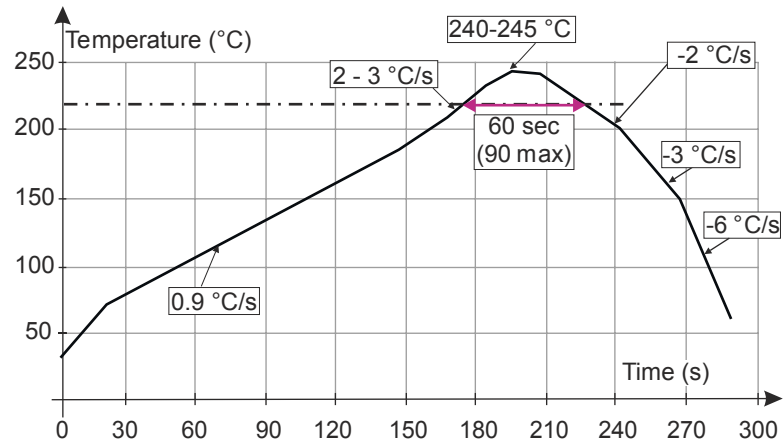

Note: Minimize air convection currents in the reflow oven to avoid component movement. Maximum soldering profile corresponds to the latest IPC/JEDEC J-STD-020.

3 Ordering information

Table 5. Ordering information

| Order code | Marking | Package | Weight | Base qty. | Delivery mode |
|------------------------------|-----------------------|---------|--------|-----------|---------------|
| SMAJxxA/CA-TR ⁽¹⁾ | See Table 6. Marking. | SMA | 71 mg | 5000 | Tape and reel |

1. Where xx correspond to V_{RM} and A or CA indicates unidirectional or bidirectional version.

Table 6. Marking

| Type | Marking | Type | Marking |
|-------------|---------|--------------|---------|
| SMAJ5.0A-TR | AE | SMAJ5.0CA-TR | AA |
| SMAJ6.0A-TR | DUB | SMAJ6.0CA-TR | DBB |
| SMAJ6.5A-TR | DUC | SMAJ6.5CA-TR | DBC |
| SMAJ8.5A-TR | DUH | SMAJ8.5CA-TR | DBH |
| SMAJ10A-TR | AX | SMAJ10CA-TR | AC |
| SMAJ12A-TR | DUK | SMAJ12CA-TR | DBK |
| SMAJ13A-TR | BG | SMAJ13CA-TR | BH |
| SMAJ15A-TR | BM | SMAJ15CA-TR | AJ |
| SMAJ18A-TR | DUQ | SMAJ18CA-TR | DBQ |
| SMAJ20A-TR | DUR | SMAJ20CA-TR | DBR |
| SMAJ24A-TR | DUT | SMAJ24CA-TR | DBT |
| SMAJ26A-TR | DUU | SMAJ26CA-TR | DBU |
| SMAJ28A-TR | CG | SMAJ28CA-TR | CH |
| SMAJ30A-TR | CK | SMAJ30CA-TR | CL |
| SMAJ33A-TR | CM | SMAJ33CA-TR | CN |
| SMAJ40A-TR | DUZ | SMAJ40CA-TR | DBZ |
| SMAJ43A-TR | EUA | SMAJ43CA-TR | EBA |
| SMAJ48A-TR | CX | SMAJ48CA-TR | CY |
| SMAJ58A-TR | EUF | SMAJ58CA-TR | EBF |
| SMAJ70A-TR | EUI | SMAJ70CA-TR | EBI |
| SMAJ85A-TR | EUL | SMAJ85CA-TR | EBL |
| SMAJ100A-TR | EUN | SMAJ100CA-TR | EBN |
| SMAJ130A-TR | EUQ | SMAJ130CA-TR | EBQ |
| SMAJ154A-TR | EUT | SMAJ154CA-TR | EBT |
| SMAJ170A-TR | SR | SMAJ170CA-TR | SS |
| SMAJ188A-TR | EUV | SMAJ188CA-TR | EBV |

Revision history

Table 7. Document revision history

| Date | Revision | Changes |
|----------------|----------|---|
| September-1998 | 5B | Previous update. |
| 02-Aug-2004 | 6 | SMA package dimensions update. Reference A1 max. changed from 2.70 mm (0.106) to 2.03 mm (0.080). |
| 10-Dec-2004 | 7 | Template layout update. No content change. |
| 10-Feb-2006 | 8 | Added unidirectional marking on cover page and Figure 14. Changed Figure 13. Foot print. |
| 14-May-2009 | 9 | Updated ECOPACK statement. Reformatted to current standards. |
| 17-Sep-2009 | 10 | Document updated for low leakage current. |
| 05-Nov-2009 | 11 | Corrected typographical error in Package information. |
| 09-Jul-2010 | 12 | Changed timescale in Figure 9. |
| 18-May-2022 | 13 | Updated Description, and Table 2. Added product status links on coverpage. |
| 31-May-2022 | 14 | Updated product links table. |
| 13-Jul-2023 | 15 | Changed "Jedec DO214-AA" to "Jedec DO214-AC". |

IMPORTANT NOTICE – READ CAREFULLY

STMicroelectronics NV and its subsidiaries (“ST”) reserve the right to make changes, corrections, enhancements, modifications, and improvements to ST products and/or to this document at any time without notice. Purchasers should obtain the latest relevant information on ST products before placing orders. ST products are sold pursuant to ST’s terms and conditions of sale in place at the time of order acknowledgment.

Purchasers are solely responsible for the choice, selection, and use of ST products and ST assumes no liability for application assistance or the design of purchasers’ products.

No license, express or implied, to any intellectual property right is granted by ST herein.

Resale of ST products with provisions different from the information set forth herein shall void any warranty granted by ST for such product.

ST and the ST logo are trademarks of ST. For additional information about ST trademarks, refer to www.st.com/trademarks. All other product or service names are the property of their respective owners.

Information in this document supersedes and replaces information previously supplied in any prior versions of this document.

© 2023 STMicroelectronics – All rights reserved