

200mW, NPN Small Signal Transistor

FEATURES

- AEC-Q101 qualified
- High current
- Low power loss, high efficiency
- Ideal for automated placement
- Moisture sensitivity level: level 1, per J-STD-020
- RoHS Compliant
- Halogen-free

APPLICATIONS

- General switching and amplification

MECHANICAL DATA

- Case: SOT-323
- Molding compound meets UL 94V-0 flammability rating
- Terminal: Matte tin plated leads, solderable per J-STD-002
- Meet JESD 201 class 2 whisker test
- Weight: 5.00mg (approximately)

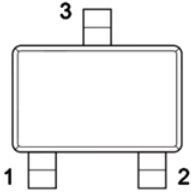
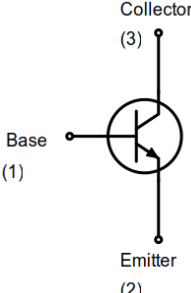

KEY PARAMETERS		
PARAMETER	VALUE	UNIT
V_{CBO}	50	V
V_{CEO}	45	V
V_{EBO}	5	V
I_C	500	mA
h_{FE}	400-600	
Configuration	Single die	

PACKAGE: SOT-323	PIN CONFIGURATION	CIRCUIT DIAGRAM
		

ABSOLUTE MAXIMUM RATINGS ($T_A = 25^\circ\text{C}$ unless otherwise noted)			
PARAMETER	SYMBOL	VALUE	UNIT
Power dissipation ⁽¹⁾	P_D	200	mW
Collector-base voltage	V_{CBO}	50	V
Collector-emitter voltage	V_{CEO}	45	V
Emitter-base voltage	V_{EBO}	5	V
Collector current	I_C	500	mA
Junction temperature	T_J	-55 to +150	$^\circ\text{C}$
Storage temperature	T_{STG}	-55 to +150	$^\circ\text{C}$

Note:

1. Device mounted on an FR4 Printed-Circuit Board (PCB), single-sided copper, tin-plated and standard footprint

THERMAL PERFORMANCE			
PARAMETER	SYMBOL	TYP	UNIT
Junction-to-ambient thermal resistance ⁽¹⁾	$R_{\theta JA}$	625	°C/W

Thermal Performance Note:

- Device mounted on an FR4 Printed-Circuit Board (PCB), single-sided copper, tin-plated and standard footprint

ELECTRICAL SPECIFICATIONS ($T_A = 25^\circ\text{C}$ unless otherwise noted)						
PARAMETER	CONDITIONS	SYMBOL	MIN	TYP	MAX	UNIT
Collector-base breakdown voltage	$I_C = 10\mu\text{A}, I_E = 0\text{A}$	$V_{(BR)CBO}$	50	-	-	V
Collector-emitter breakdown voltage	$I_C = 10\text{mA}, I_B = 0\text{A}$	$V_{(BR)CEO}$	45	-	-	V
Emitter-base breakdown voltage	$I_E = 1\mu\text{A}, I_C = 0\text{A}$	$V_{(BR)EBO}$	5	-	-	V
Collector-base cut-off current	$V_{CB} = 20\text{V}, I_E = 0\text{A}$	I_{CBO}	-	-	0.1	μA
Emitter-base cut-off current	$V_{EB} = 5\text{V}, I_C = 0\text{A}$	I_{EBO}	-	-	0.1	μA
DC current gain	$V_{CE} = 1\text{V},$ $I_C = 100\text{mA}$	h_{FE}	160	-	400	-
	BC817-25WH		250	-	600	
	$V_{CE} = 1\text{V}, I_C = 500\text{mA}$	40	-	-		
Collector-emitter saturation voltage	$I_C = 500\text{mA}, I_B = 50\text{mA}$	$V_{CE(sat)}$	-	-	0.7	V
Base-emitter saturation voltage	$I_C = 500\text{mA}, I_B = 50\text{mA}$	$V_{BE(sat)}$	-	-	1.2	V
Base-emitter voltage	$V_{CE} = 1\text{V}, I_C = 500\text{mA}$	V_{BE}	-	-	1.2	V
Transition frequency	$V_{CE} = 5\text{V}, I_C = 10\text{mA},$ $f = 100\text{MHz}$	f_T	100	-	-	MHz
Output capacitance	$V_{CB} = 10\text{V}, I_E = 0\text{A},$ $f = 1\text{MHz}$	C_{obo}	-	5	-	pF

ORDERING AND MARKING INFORMATION			
ORDERING CODE	PACKAGE	PACKING	DEVICE MARKING
BC817-25WH RFG	SOT-323	3,000 / 7" Tape & Reel	<u>6</u> B
BC817-40WH RFG	SOT-323	3,000 / 7" Tape & Reel	<u>6</u> C

CHARACTERISTICS CURVES

($T_A = 25^\circ\text{C}$ unless otherwise noted)

Fig.1 Power Dissipation Curve

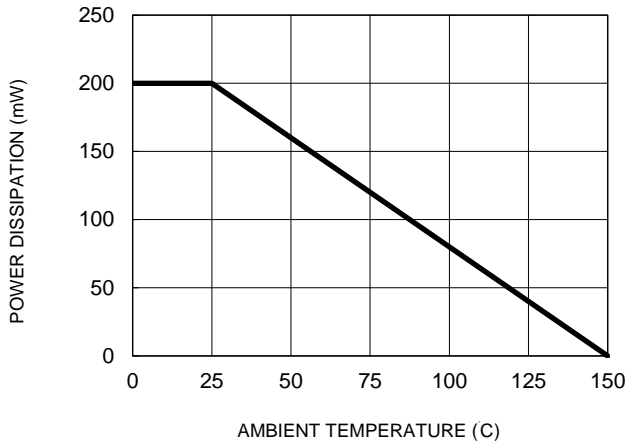

Fig.2 Typical Capacitance Characteristics

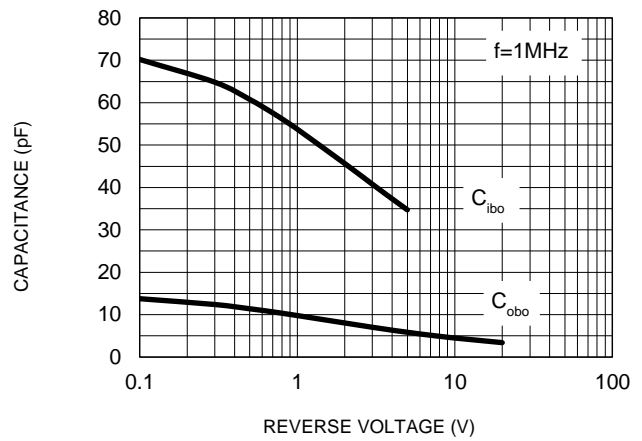

Fig.3 DC Current Gain vs. Collector Current

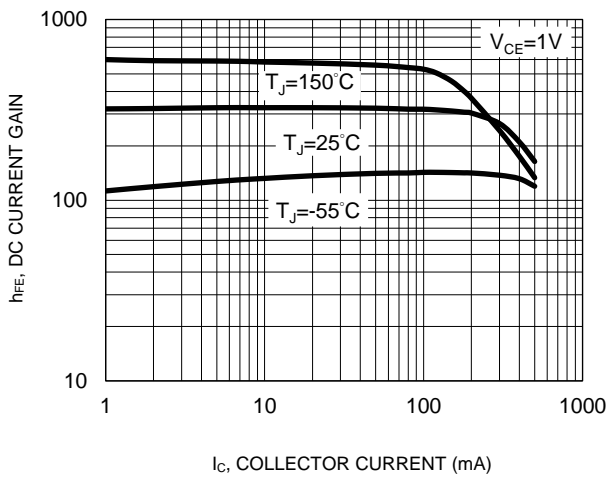

Fig.4 Collector-Emitter Saturation Voltage vs. Collector Current

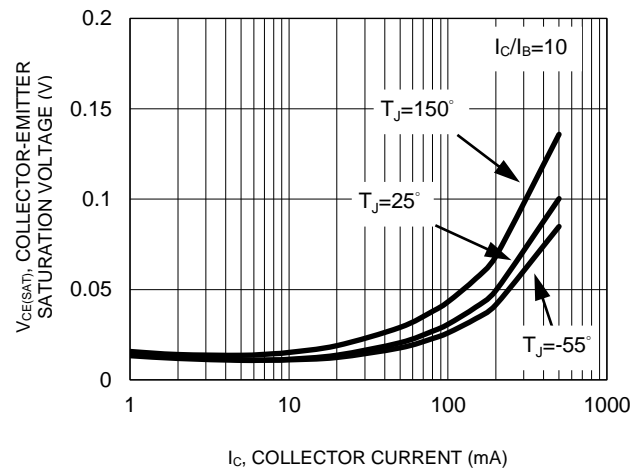

Fig.5 Base-Emitter Saturation Voltage vs. Collector Current

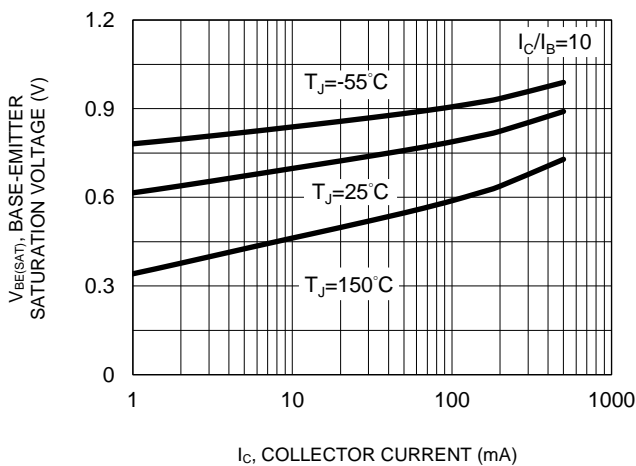
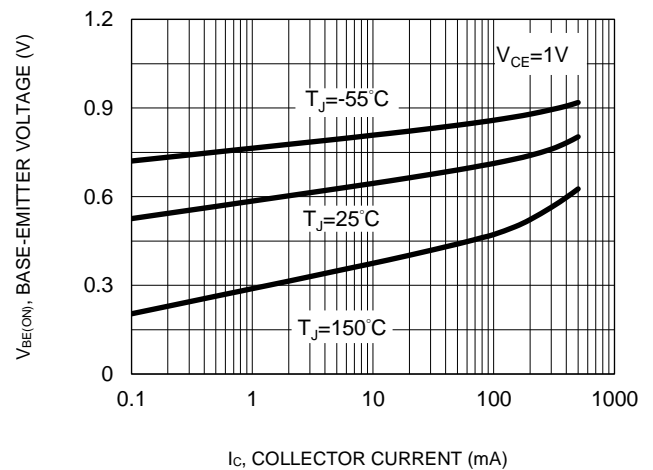
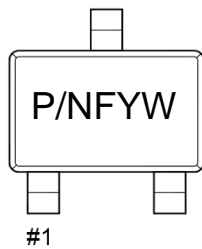
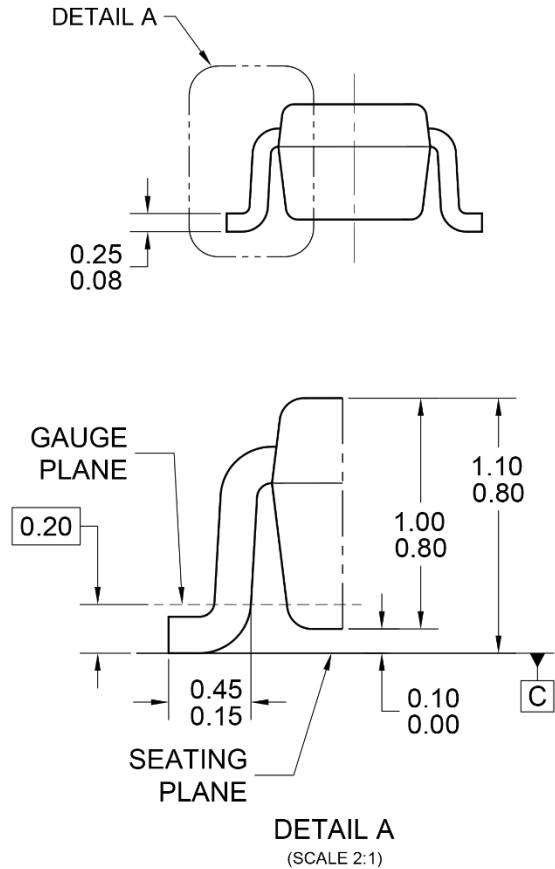
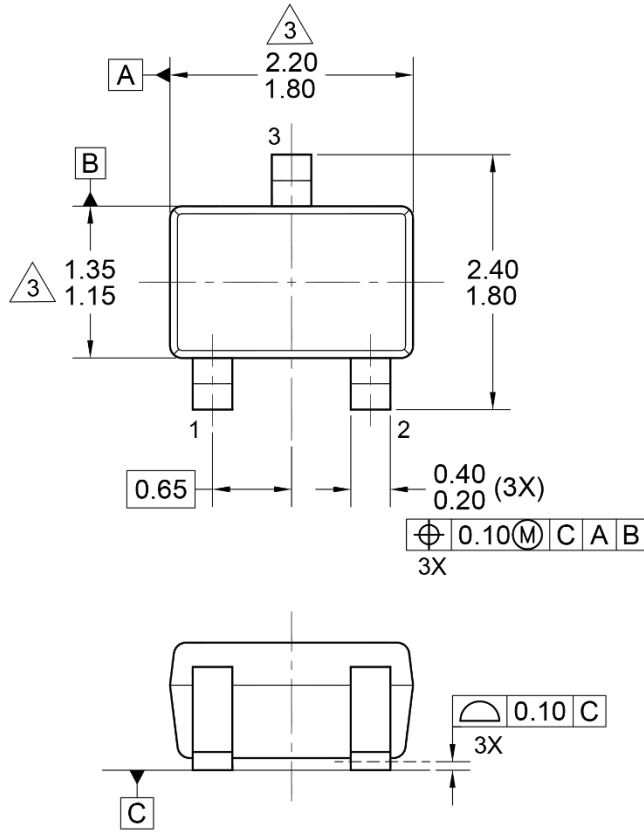

Fig.6 Base-Emitter Voltage vs. Collector Current



PACKAGE OUTLINE DIMENSIONS

SOT-323



MARKING DIAGRAM

P/N = Device marking Y = Year code
F = Factory code W = Bi-Week code (A~Z)

NOTES: UNLESS OTHERWISE SPECIFIED

1. ALL DIMENSIONS ARE IN MILLIMETERS.
2. DIMENSIONING AND TOLERANCING PER ASME Y14.5M-1994.
3. PACKAGE OUTLINE REFERENCE: JEITA ED-7500A, EIAJ SC-70.
4. DIMENSIONS D AND E DO NOT INCLUDE MOLD FLASH, PROTRUSIONS OR GATE BURRS.
5. DWG NO. REF: HQ2SD07-SOT323-098 REV D.

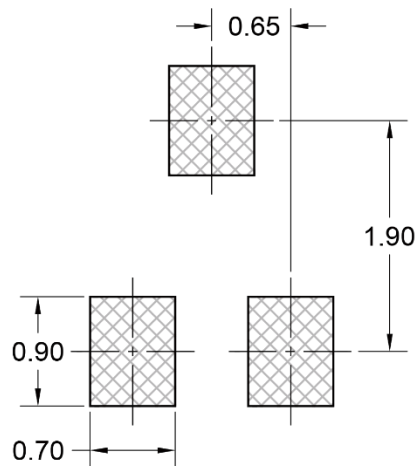

SUGGESTED PAD LAYOUT

Notice

Specifications of the products displayed herein are subject to change without notice. TSC or anyone on its behalf, assumes no responsibility or liability for any errors or inaccuracies.

Purchasers are solely responsible for the choice, selection, and use of TSC products and TSC assumes no liability for application assistance or the design of Purchasers' products.

Information contained herein is intended to provide a product description only. No license, express or implied, to any intellectual property rights is granted by this document. Except as provided in TSC's terms and conditions of sale for such products, TSC assumes no liability whatsoever, and disclaims any express or implied warranty, relating to sale and/or use of TSC products including liability or warranties relating to fitness for a particular purpose, merchantability, or infringement of any patent, copyright, or other intellectual property right.

The products shown herein are not designed for use in medical, life-saving, or life-sustaining applications. Customers using or selling these products for use in such applications do so at their own risk and agree to fully indemnify TSC for any damages resulting from such improper use or sale.